

## 0.95-2GHz 360Degree Analog Phase Shifter



### Description:

The AT-APS-0102-360 is an Analog Phase Shifter which is controlled via an analog control voltage from 0 to +14V.

It provides a continuous variable phase shift of 0 to 360 degrees from 0.95GHz to 2GHz with consistent insertion loss versus phase shift. The phase shift is monotonic with respect to control voltage.

### Feature

- ✓ Wide Band Operation 0.95-2GHz
- ✓ 360 degree Phase Shift
- ✓ Low Insertion Loss
- ✓ Single Control Operation
- ✓ Customized Available

### Application

- ✓ Point to Point Radios
- ✓ VSAT Radios
- ✓ Test Equipment
- ✓ Fiber Optic
- ✓ Military and Space

### Electronical Specifications:

Parameter	Min	Typical	Max	Unit
Frequency Range		0.95-2		GHz
Phase Range		360		Degree
Insertion Loss		-5		dB
Return Loss		-12		dB
Control Voltage		0-14		V
Control Current		1		uA
Sensitivity		28		Deg/V
Response Time		250		ns
Temperature Sensitivity		0.1		Degree/C
Spec Temp		25C		





# AT-APS-0102-360

Analog Phase Shifter, 0.95-2GHz, 360 degree

## Mechanical Information

Item	Description
Input Port	SMA Female
Output Port	SMA Female
Case Material	Copper
Finish	Gold Plated
Package Sealing	Epoxy Sealed
Weight	80g
Size:	See outline

## Absolute Maximum Ratings Table

Parameter	Value
Control Voltage	-0.5 to +18V
RF Input Power	+15dBm
Operating Temperature	-40 to +85C
Storage Temperature	-65 to +150C
ESD Sensitive(HBM)	Class 1B

### Notes:

- ✓ Datasheet may be changed according to update of MMIC, Raw materials , process, and so on.
- ✓ This data is only for reference, not for guaranteed specifications.
- ✓ Please contact AT Microwave team to make sure you have the most current data.
- ✓ Always pay attention to the temperature of the case, heatsink and fan are required if case temperature exceeds over 50C.



移相VS频率@Pin=-10dBm (Vt=0.5V~15V)

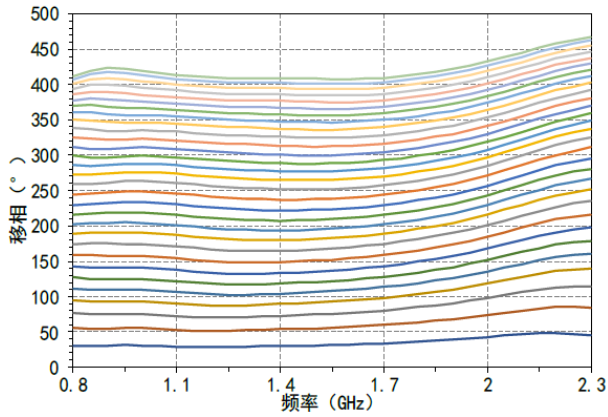

移相VS Vt@Pin=-10dBm

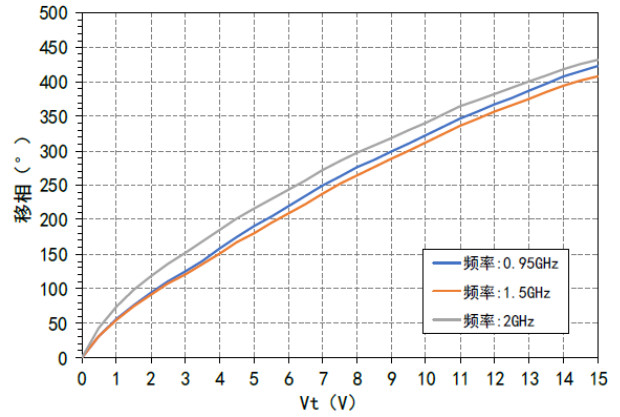

移相VS频率@Vt=14V

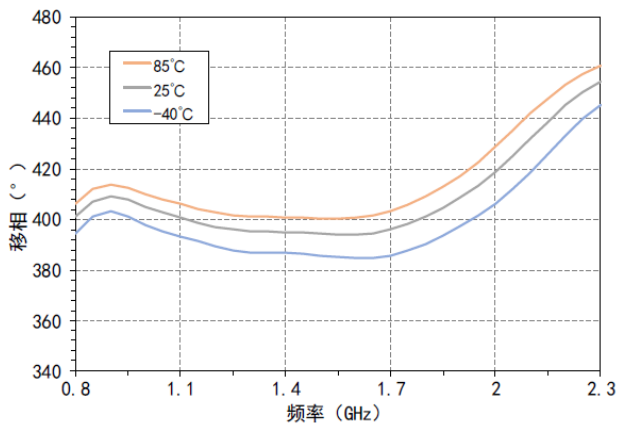

移相VS Vt@1.5GHz

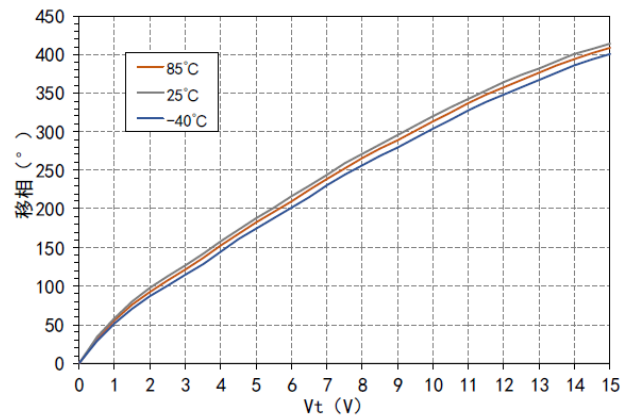

插入损耗VS Vt@Pin=-10dBm

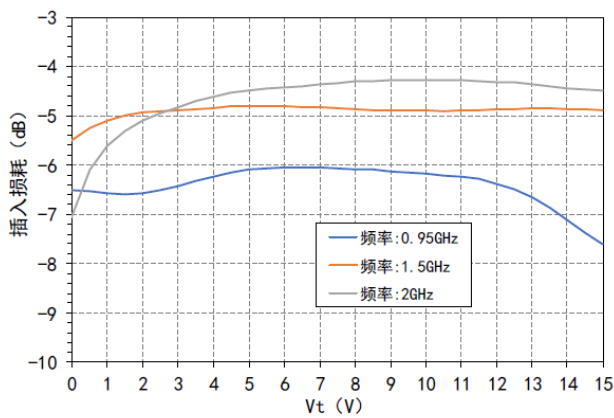

插入损耗VS Pin@1.5GHz

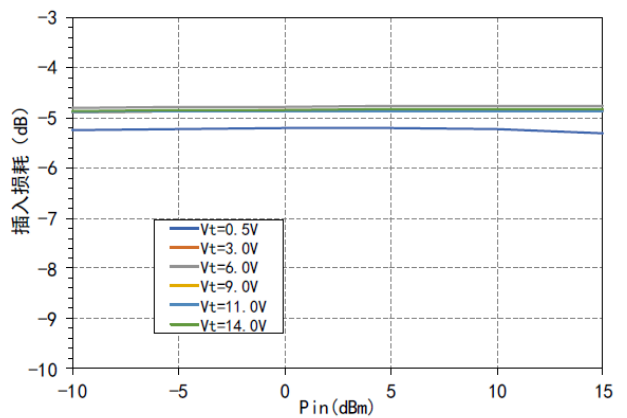

**Dimension:** (unit in mm)

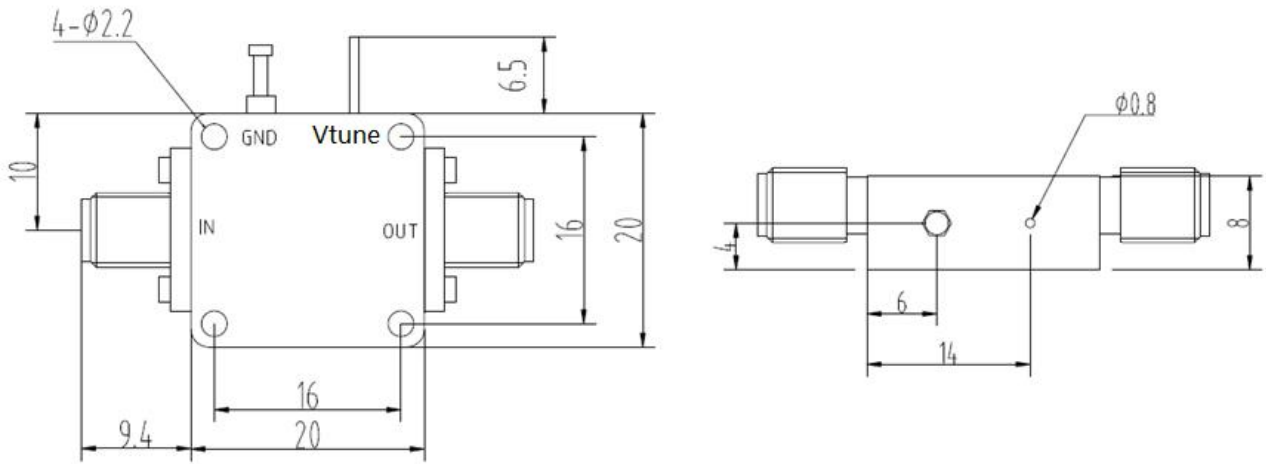

	<26.5GHz	<40GHz	<50GHz	<67GHz
Connector	SMA	2.92mm	2.4mm	1.85mm
Lenth of a	9.4mm	9.5mm	10.8mm	11.3mm

Note: Female Default. Contact with us for other types.

